



Thermobox fan type KBR

The KBR fans have galvanized steel impellers with backward curved blades and external outer pole motors. The KBR house is made of double-walled galvanized sheet steel and is insulated with 50 mm mineral wool.

The KBR fans have a swing-out door for easy inspection and maintenance. The direction of the door opening can be easily changed from left to right on site.

Connectors and vibration dampers are integrated in the base frame. To protect the motor from overheating, the KBR fans are equipped with integrated cold conductors (PTC).

High efficiency AC motors for both 50 and 60 Hz. Possible in IE2 or IE3 versions.

- Max temperature of transported air 120°C
- Speed controllable via frequency inverter
- Internal cold conductors (PTC)
- Low sound level

General data:

Max Air flow	2.164	m3/h
Impeller speed	1.461	rpm
Input power	239	W
Voltage (nominal)	3x400/50	V/Hz
Input current	1,23	A
Enclosure class, motor	54	IP
Weight	120	°C
Max. Temperature of transported air	53	kg
Max. temperature of transported air, when speed controlled	38,5	dB(A)

Sound pressure level $\pm 2^*$

**(at 13m near the fan with inlet and outlet ducted, in free field)*

Options:

rain cover	rain cover
Flexible	Flexible suction side (max. 120 ° C)
five-step transformer	STRS4-15L40
frequency converter FRQ5S	FRQ5S-4A
frequency converter FRQS	FRQS-4A
MTV	--
MTP	--

Curve:



Dimensions:

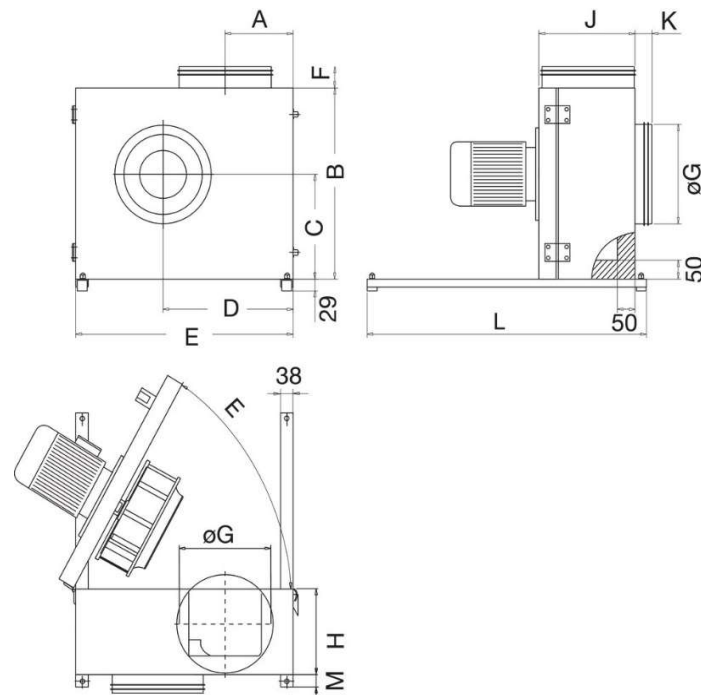

A	B	C	D	E	F
187,5	600	339	398	690	125
øG	H	J	K	L	M
315	249	307	70	770	55