



Axial wall fan model AW.

The free-running impeller is made of high-quality composite material (sizes 200-450) or black cast aluminum (sizes 450-1000) with energetically optimized geometry. Model 300E2 has a sickle blade impeller made of black coated sheet metal.

It is powered by a highly efficient outer pole motor. To protect the motor from burning, the fan has internal contacts with wires routed outwards for connection to a motor protection. Motor is cooled because it is placed in the air stream. Adjustable by means of transformer and star / delta control.

This fan has a high efficiency, excellent noise level and is maintenance-free and reliable. It is made of galvanized steel and then powder coated black (RAL9005). Supplied with protective grille (sizes 200-630), for larger models (sizes 710-1000) it is an accessory.

General data:

Max Air flow	7.301	m ³ /h
Impeller speed	1.393	rpm
Input power	607	W
Voltage (nominal)	1x230/50	V/Hz
Input current	2,88	A
Enclosure class, motor	54	IP
Weight	16,2	kg
Max. Temperature of transported air	70	°C
Max. temperature of transported air, when speed controlled	70	°C
Sound pressure level ±2*	64	dB(A)

* (at 1,5 m near the fan with inlet and outlet ducted, in free field)

Options:

Louvre shutter, plastic	VK 450
five-step transformer	STRA1-35L22

Curve :

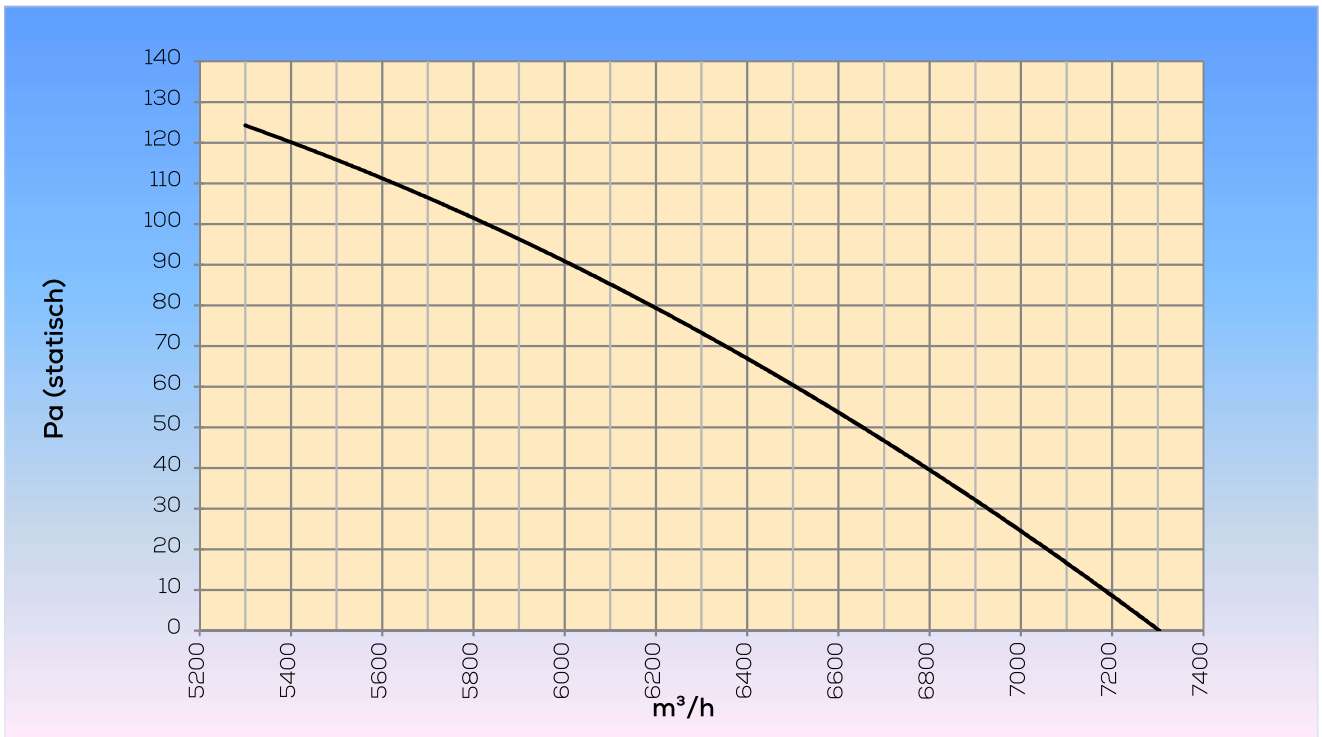

Dimensions:

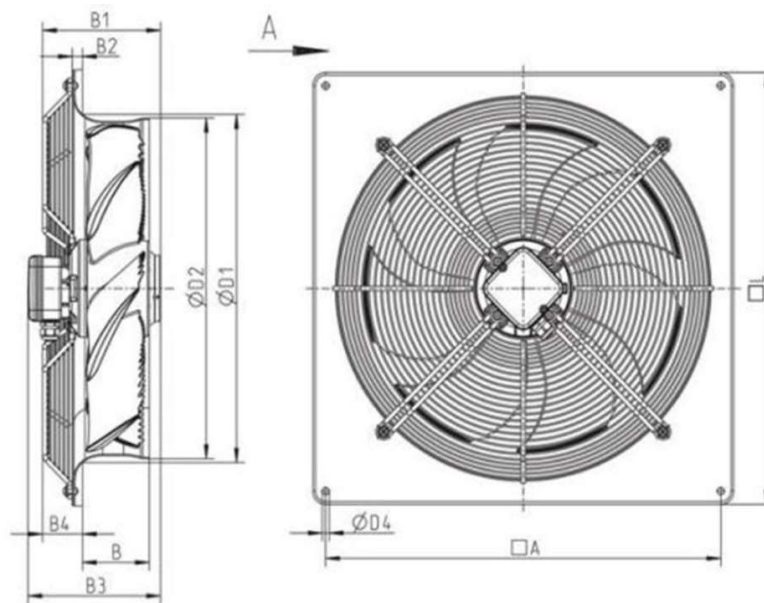

□A	B	B1	B2	B3
535	96	190	14	226

B4	ØD1	ØD2	ØD4	□L
47	480	463	11	575