



Axial fan model AR

The free-running axial impeller is made of high-quality composite material (sizes 200-450) or aluminum (sizes 450-1000) with a specially designed blade geometry.

This fan has a high efficiency, excellent noise level and is maintenance-free and reliable. It is made of galvanized steel and then powder coated black (RAL9005). Circular housing with flanges that meet Eurovent ½. Supplied with protective grille (sizes 200-630), for larger models (sizes 710-1000) it is an accessory.

Voltage controllable external rotor motors. Adjustable via voltage reduction using a transformer or thyristor. Star delta is possible for 3 ~ / 400 V types. To protect the motor from burning, the fan has internal contacts with wires routed outwards for connection to a motor protection.

General data:

Max Air flow	11.339	m ³ /h
Impeller speed	1.280	rpm
Input power	1.044	W
Voltage (nominal)	3x400/50	V/Hz
Input current	2,2	A
Enclosure class, motor	54	IP
Weight	23,2	kg
Max. Temperature of transported air	70	°C
Max. temperature of transported air, when speed controlled	70	°C
Sound pressure level ±2*	71	dB(A)

* (at 1,5 m near the fan with inlet and outlet ducted, in free field)

Options:

Louvre shutter, plastic	VK 560
five-step transformer	STRS4-25L40

Curve :

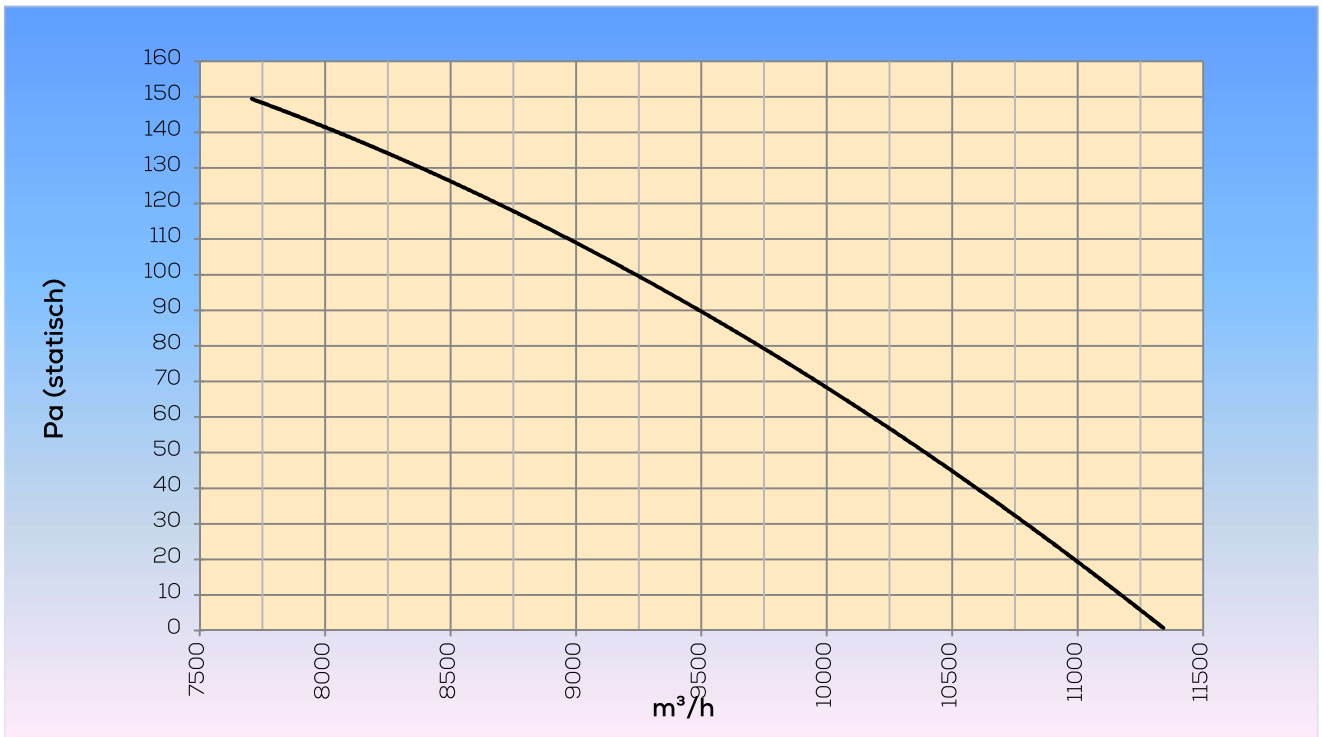

Dimensions:

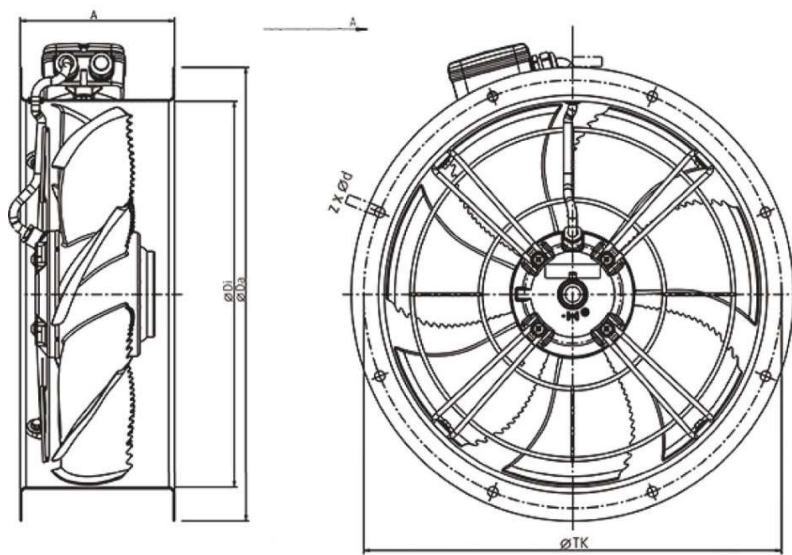

A	Ødi	ØDa	ØTK	z x Ød
235	559	650	620	12 x Ø11,5