



VK plastic louvre shutter for AW axial wall fans
 Self-closing square louvre valve
 Weather resistant (UV-resistant)
 Temperature range from -30°C to $+60^{\circ}\text{C}$
 Suitable for vertical mounting on the wall
 The profiles of the valve have a upward force that reduces air resistance so the valve will also open with low air velocities.
 All parts are made of durable material (PVC)
 The heavy construction makes the valve extra strong, so the profiles will not loosen or deform
 The airspeed cannot be higher than 12 meter per second Wall plows and screws are delivered with the package
 Light gray RAL 7035

Technical parameters

Material	PVC	
Weight	1,4	kg
Max. medium temp.	60	$^{\circ}\text{C}$

Suitable for

	Type
Axial fan	AW 500 E4
Axial fan	AW 500 D4

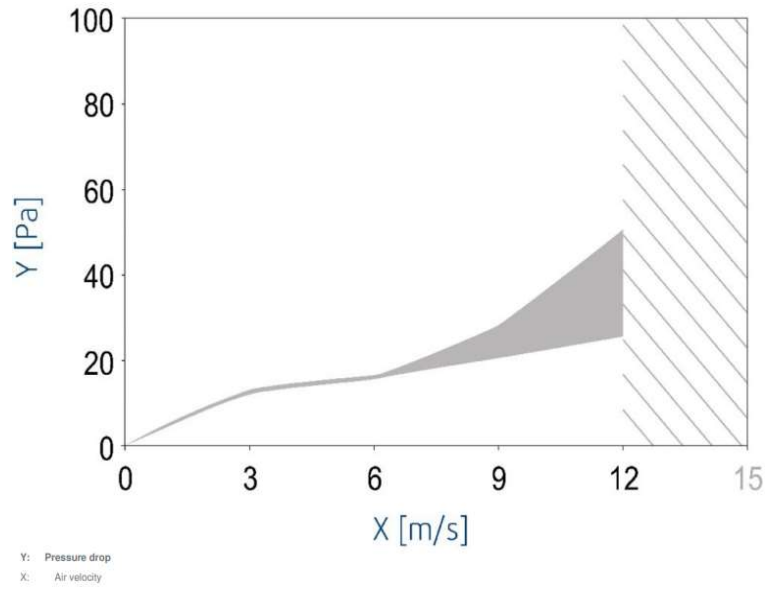

Dimensions:

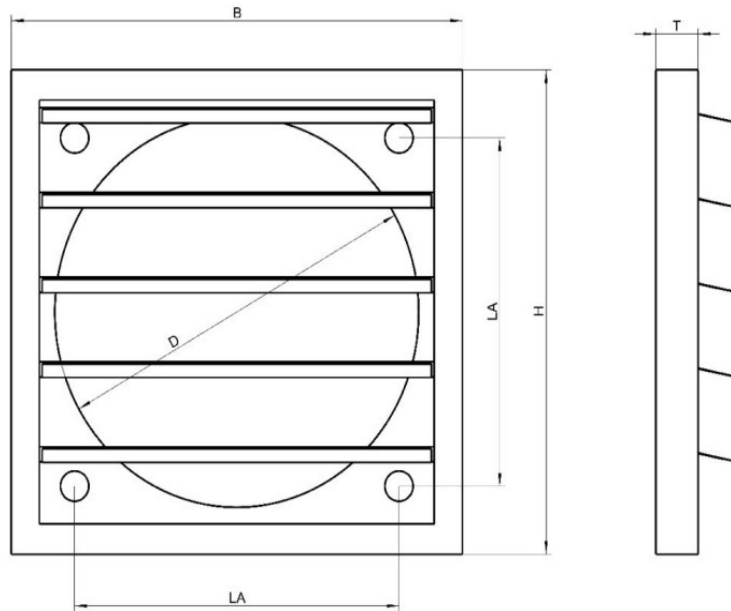

Type	D	H/B	LA	T	weight (kg)
VK500	505	548	443	31	1,4