

## Protection guard SG Ø500

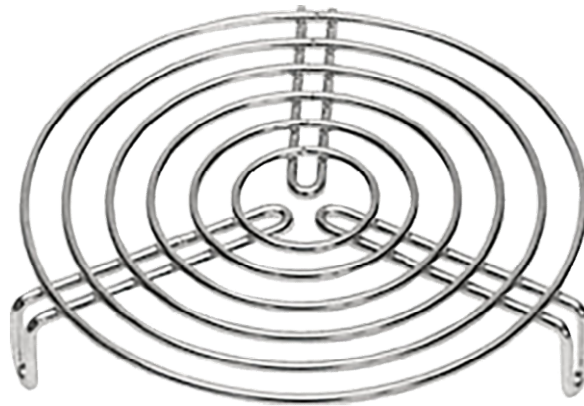

Protection guard for duct fans, mounted with three screws

### General data:

Weight 1,2 kg

### Dimension:

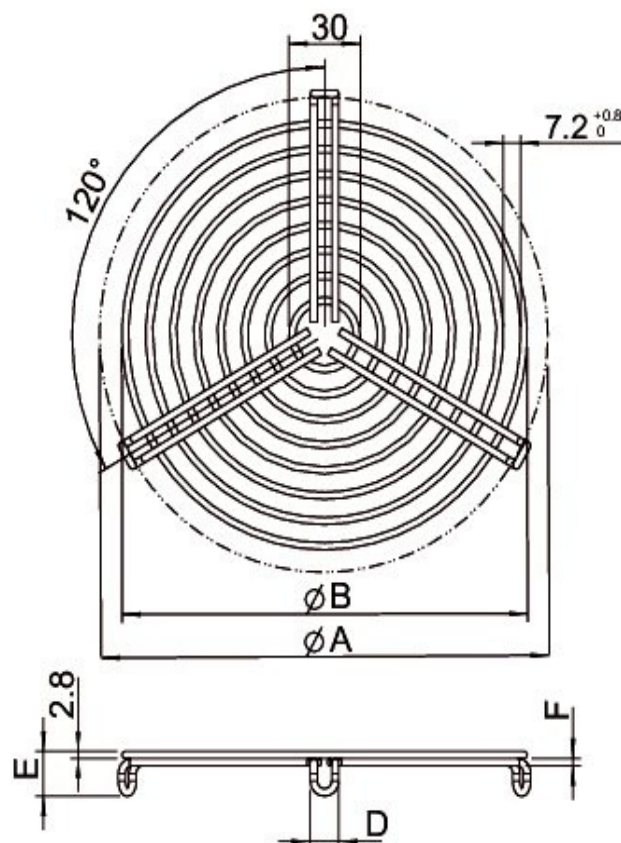

ØA	ØB	D	E	F
500	490	12,6	24,7	3,8