

Protection guard SG Ø400

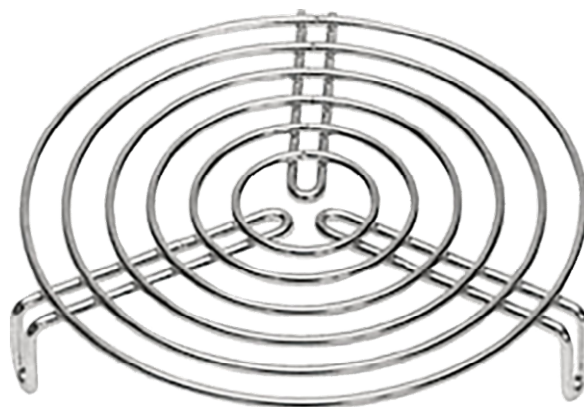

Protection guard for duct fans, mounted with three screws

General data:

Weight 0,7 kg

Dimension:

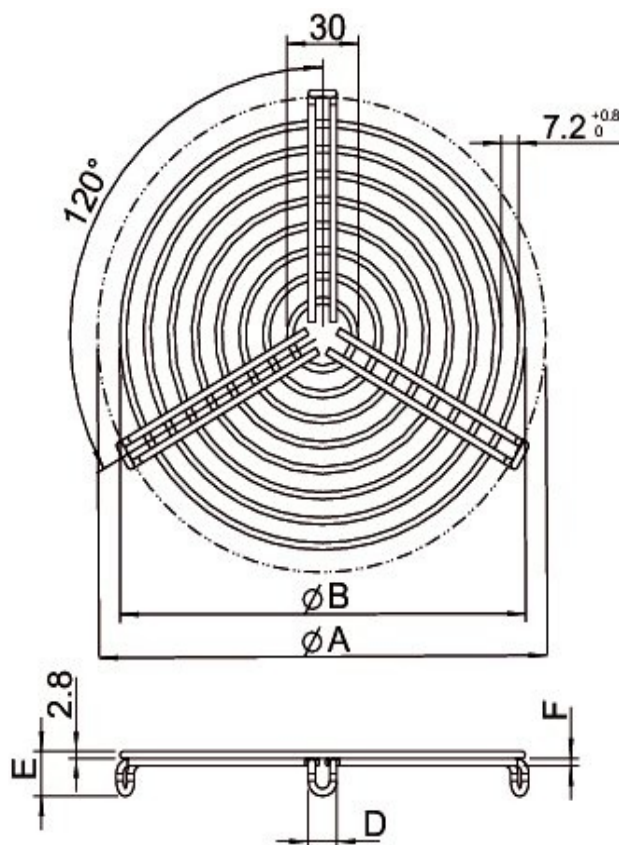

ØA	ØB	D	E	F
400	390	12,6	24,7	3,8