

## Protection guard SG Ø315

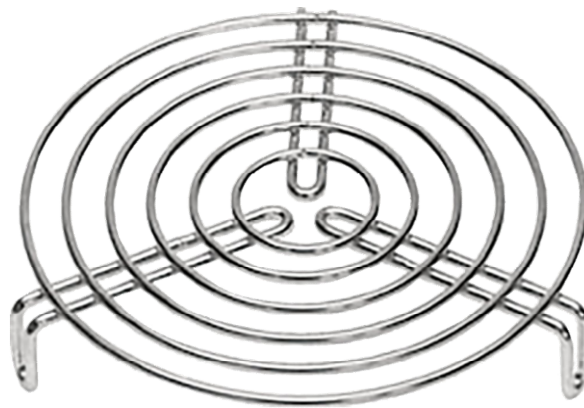

Protection guard for duct fans, mounted with three screws

### General data:

Weight 0,46 kg

### Dimension:

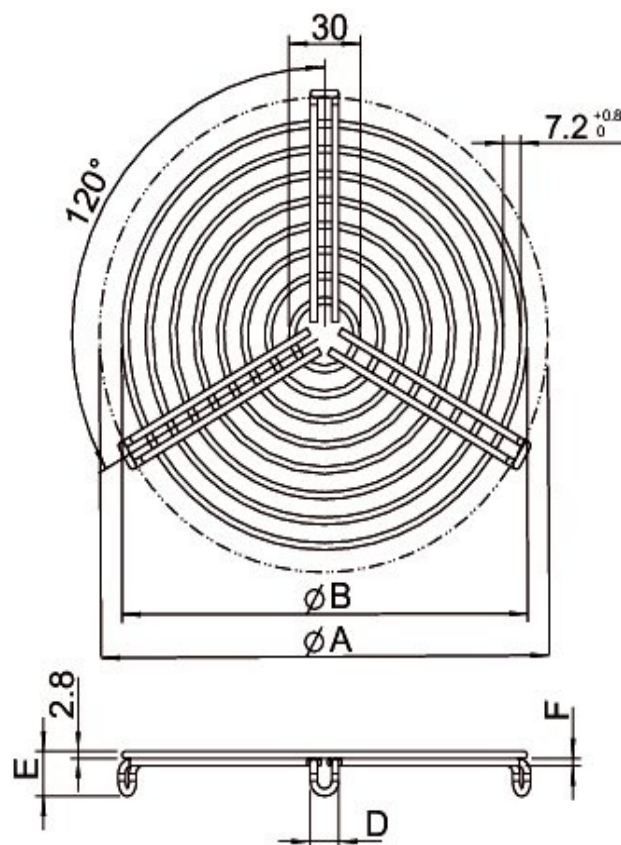

ØA	ØB	D	E	F
315	310	12,6	24,7	3,8