

Protection guard SG Ø250

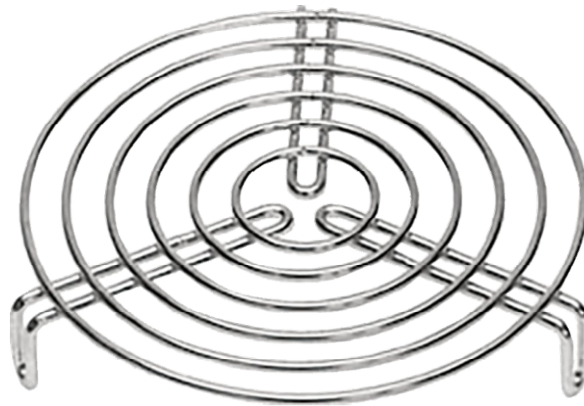

Protection guard for duct fans, mounted with three screws

General data:

Weight 0,2 kg

Dimension:

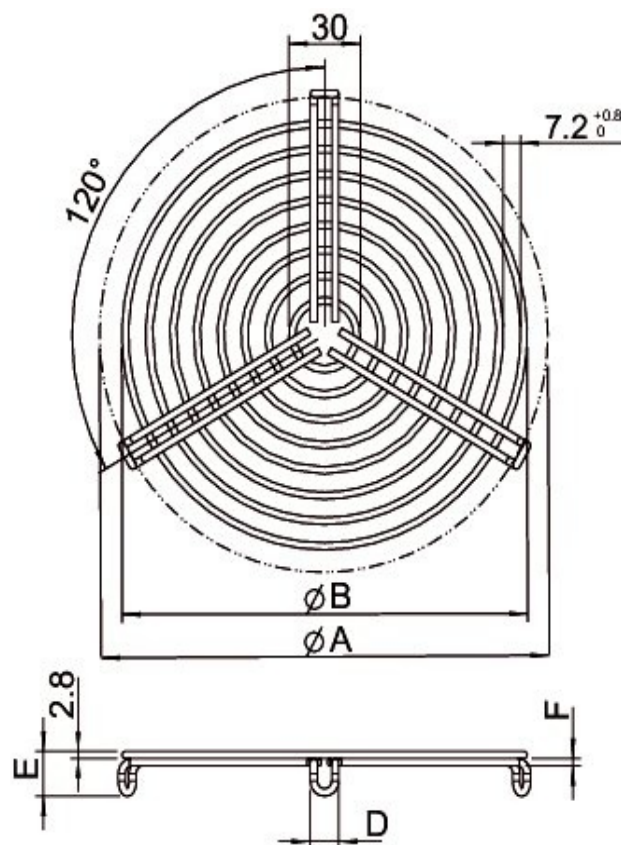

ØA	ØB	D	E	F
250	250	11,8	24,3	3,4