

## Protection guard SG Ø200

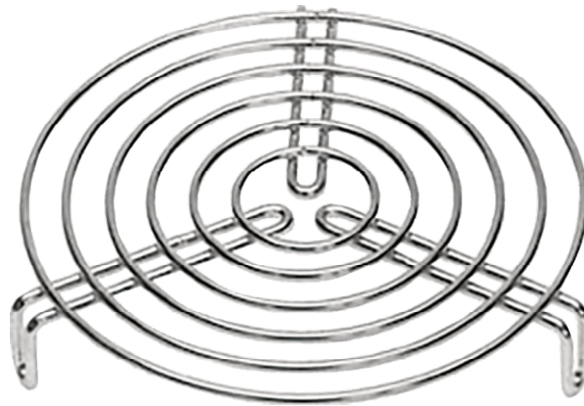

Protection guard for duct fans, mounted with three screws

### General data:

Weight 0,2 kg

### Dimension:

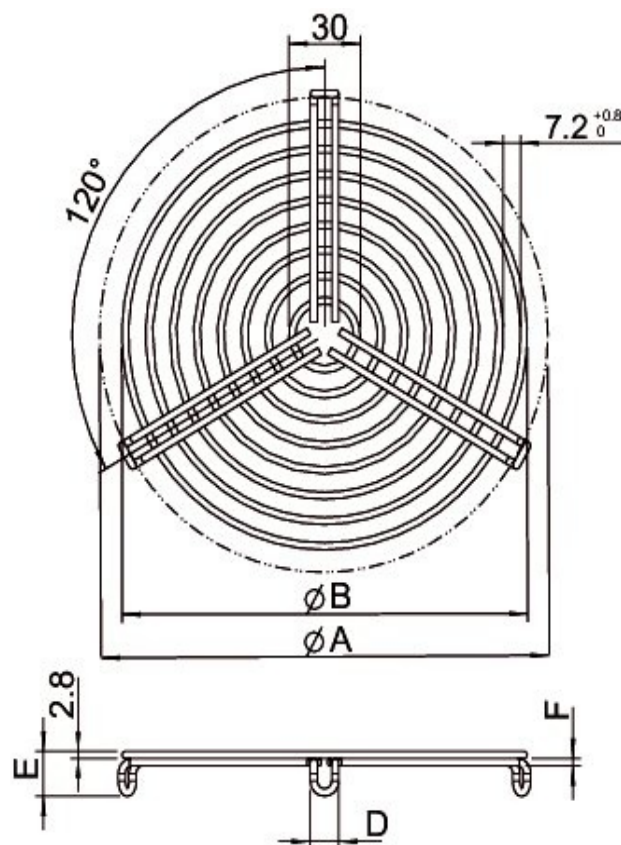

ØA	ØB	D	E	F
200	190	11,8	24,3	3,4