

## Protection guard SG Ø150

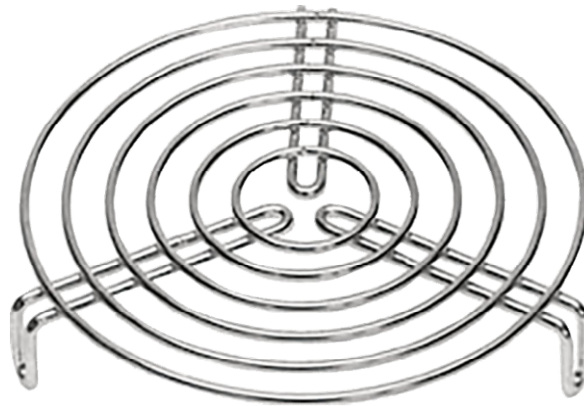

Protection guard for duct fans, mounted with three screws

### General data:

Weight 0,1 kg

### Dimension:

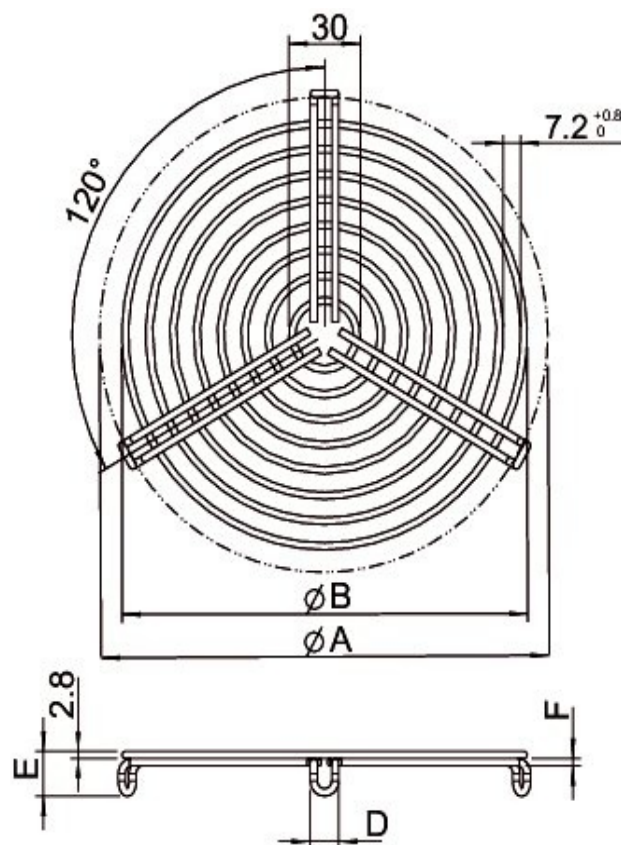

ØA	ØB	D	E	F
150	150	11,8	24,3	3,4