

Protection guard SG Ø125

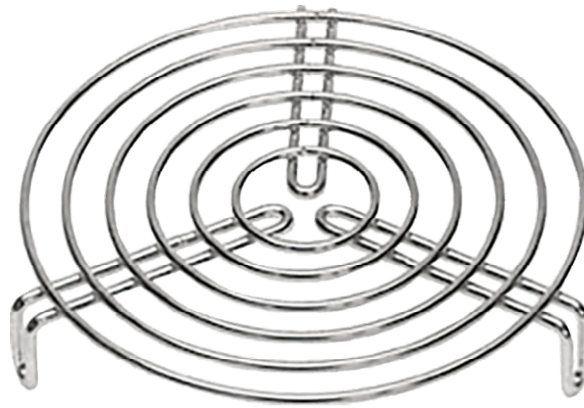

Protection guard for duct fans, mounted with three screws

General data:

Weight 0,1 kg

Dimension:

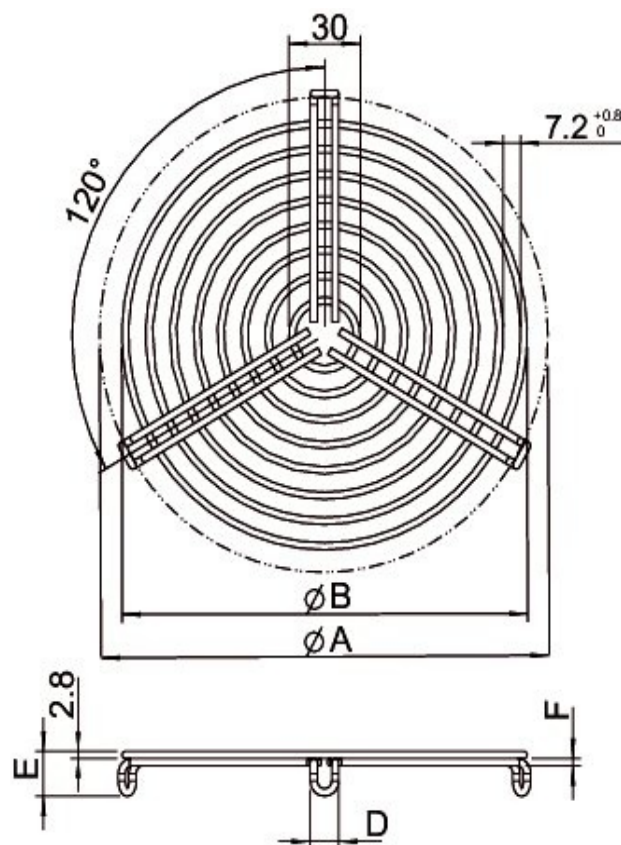

ØA	ØB	D	E	F
125	110	11,8	24,3	3,4