

Protection guard SG Ø100

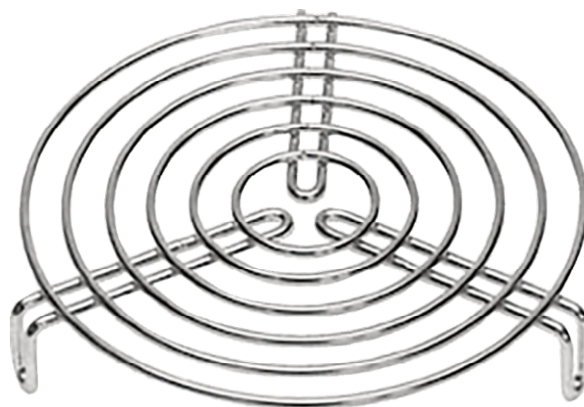

Protection guard for duct fans, mounted with three screws

General data:

Weight 0,05 kg

Dimension:

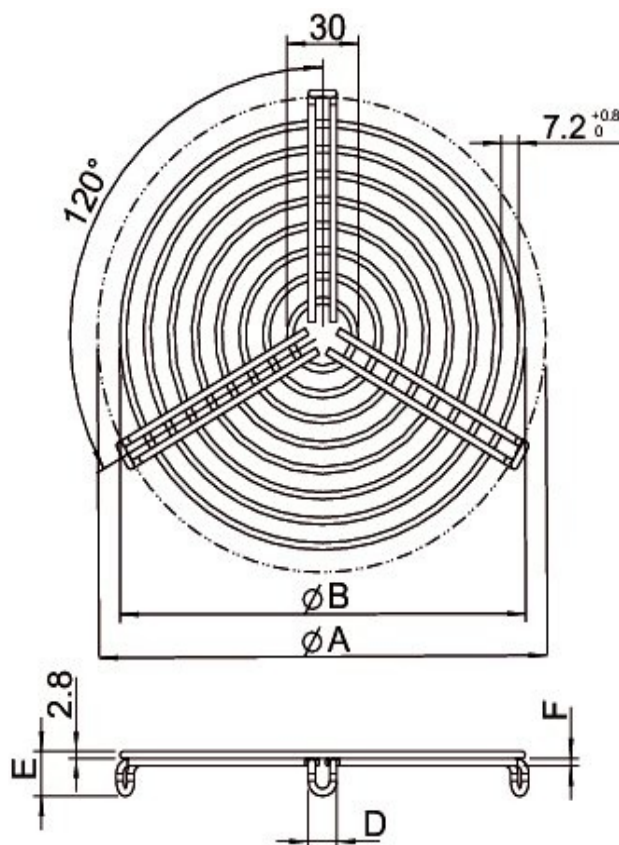

ØA	ØB	D	E	F
100	90	11,8	24,3	3,4