

Technical parameters

Unit name: VKA 125 EKO
Art.no:

Date: 2020-06-11
Order number

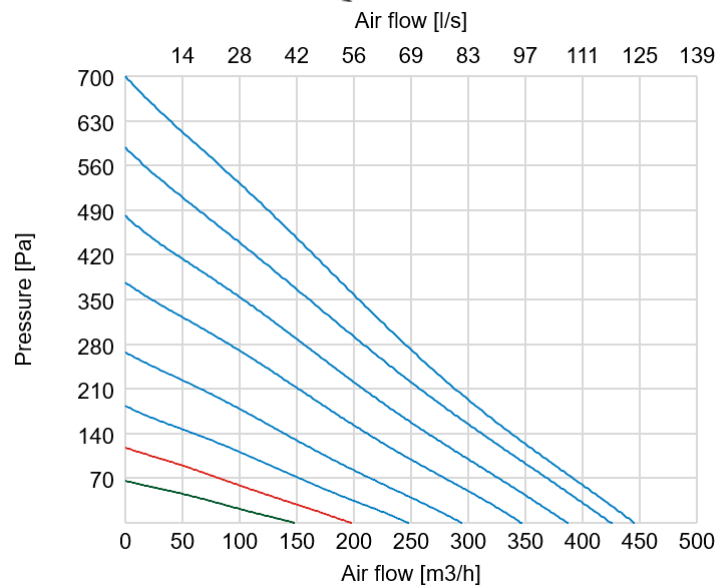

Technical parameters

Max air flow	m³/h	446
Max pressure	Pa	698
Voltage/Frequency	VAC/Hz	230/50
Power	W	83
Enclosure class		54
RPM		3200
Current	A	0.88
Phases		1
Weight [kg]	kg	2.1

Climate data

Air flow	Air flow	1000m³/h
Pressure drop duct system	External pressure (Supply)	600Pa

Technical parameters

Unit name: VKA 125 EKO

Date: 2020-06-11

Art.no:

Order number

Dimensions

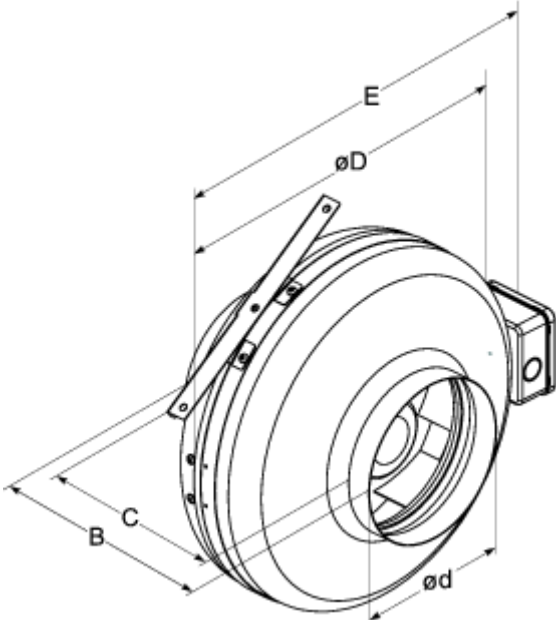

B (mm)	C (mm)	D (mm)	d (mm)	E (mm)
207	175±2	245	125	290