

MF 500D6/A



Axial wall fan model MF.

With our extensive range of standard Wall Fans, we offer a wide range of reliable and efficient fans.

These robust fans are used for various applications in horticulture, pig farming, dairy farming, poultry farming, and industrial markets.

These fans are specially designed for heavy corrosive environments and can also be used outdoors. These Wall Fans are optionally available with the energy-efficient ECplus technology.

General info:

Max. aircapacity	6550	m3/h
Material impeller	PG	
Impeller blades	6	
Impeller speed	965	rpm
Power	0,21	kW
Electric supply	3x230-400/50	V/Hz
Nominal / Max current	0,9/0,5	1/0,6 A
Enclosure	55	IP
Weight	14,2	kg
Max./Min. medium temp.	40	-25 °C
Sound pressure level ±2*	59	dB(A)

* (at 2m near the fan with inlet and outlet ducted, in free field)

Options:

5-stands regulating transformer	On Request
Air intake and exhaust wireguards	On Request
System 1 weather hood	On Request
Other regulators	On Request

MF 500D6/A

Graph:

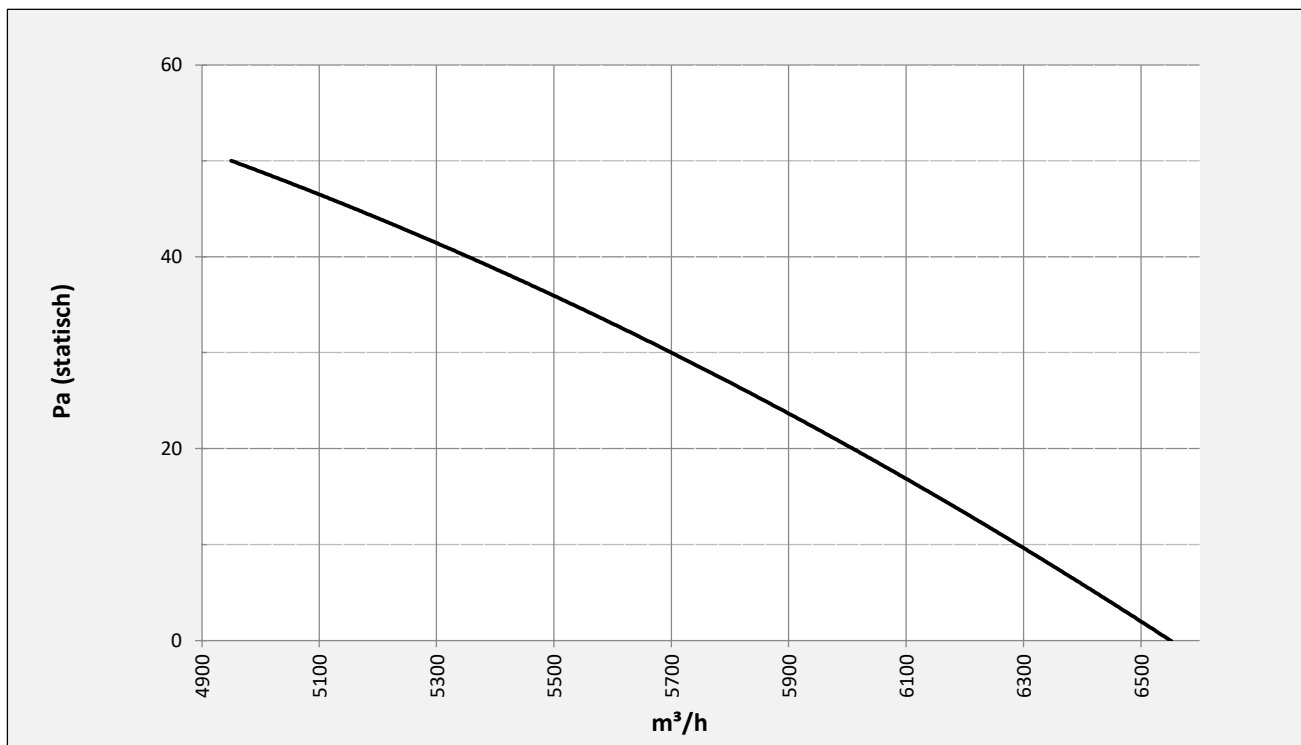

Dimensions:

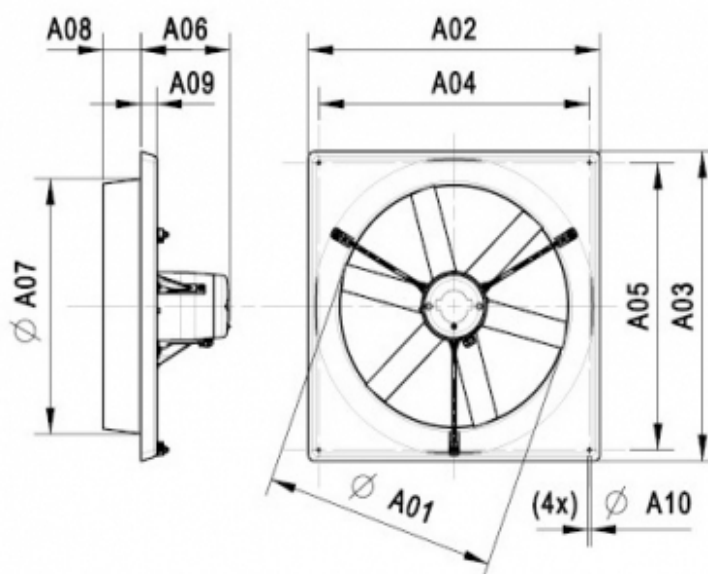

A01	A02	A03	A04	A05	A06	A07	A08	A09	A10
512	648	648	600	600	192	540	84	36	8